



New World
RESOURCES

**One of the Highest-Grade Emerging Copper Development Projects in
the World – With Compelling Exploration Upside**

**The Antler Copper
Project, Arizona, USA**

November 2023



Corporate – ASX:NWC

Share Price

A\$0.032

52 week high: \$0.062 low: \$0.024

Market Capitalisation

A\$72.4m

At A\$0.032/share

Shares on Issue

2,261.7m

Cash

A\$14.0m

30 September 2023 plus \$11.0m from sale of 0.9% royalty to Trident Royalties Plc

Performance Rights

22.7m

Held by Management Team

Options

125.8m

Exercisable A\$0.046 - A\$0.0635

Board and Officers

Richard Hill

Mike Haynes

Nick Woolrych

Tony Polglase

Ian Cunningham

Beverley Nichols

Non-Executive Chairman

Managing Director/CEO

Exec. Director & COO

Non-Executive Director

Company Secretary

Chief Financial Officer



Shareholders

Resource Capital Funds Opportunities Fund II	6.9%
Ponderosa Investments WA Pty Ltd	6.0%
Paradice Investment Management	4.9%
Management	4.1%
Top 20	48.8%

New World Has Two Clear Corporate Objectives

1. Advance the Antler Copper Deposit to Production as Quickly as Practicable

2. Continue to Increase the Resource Base:
- At the Antler Project; and
 - Within Trucking Distance of Antler



Antler Copper Project – Excellent Jurisdiction

70% of US Copper is Mined in Arizona

Arizona Ranked 7th - 2022 Fraser Institute

Antler Deposit on Private Land

Very Sparsely Populated

18-Month Permitting at Moss Mine

Mining Resuming at Mineral Park

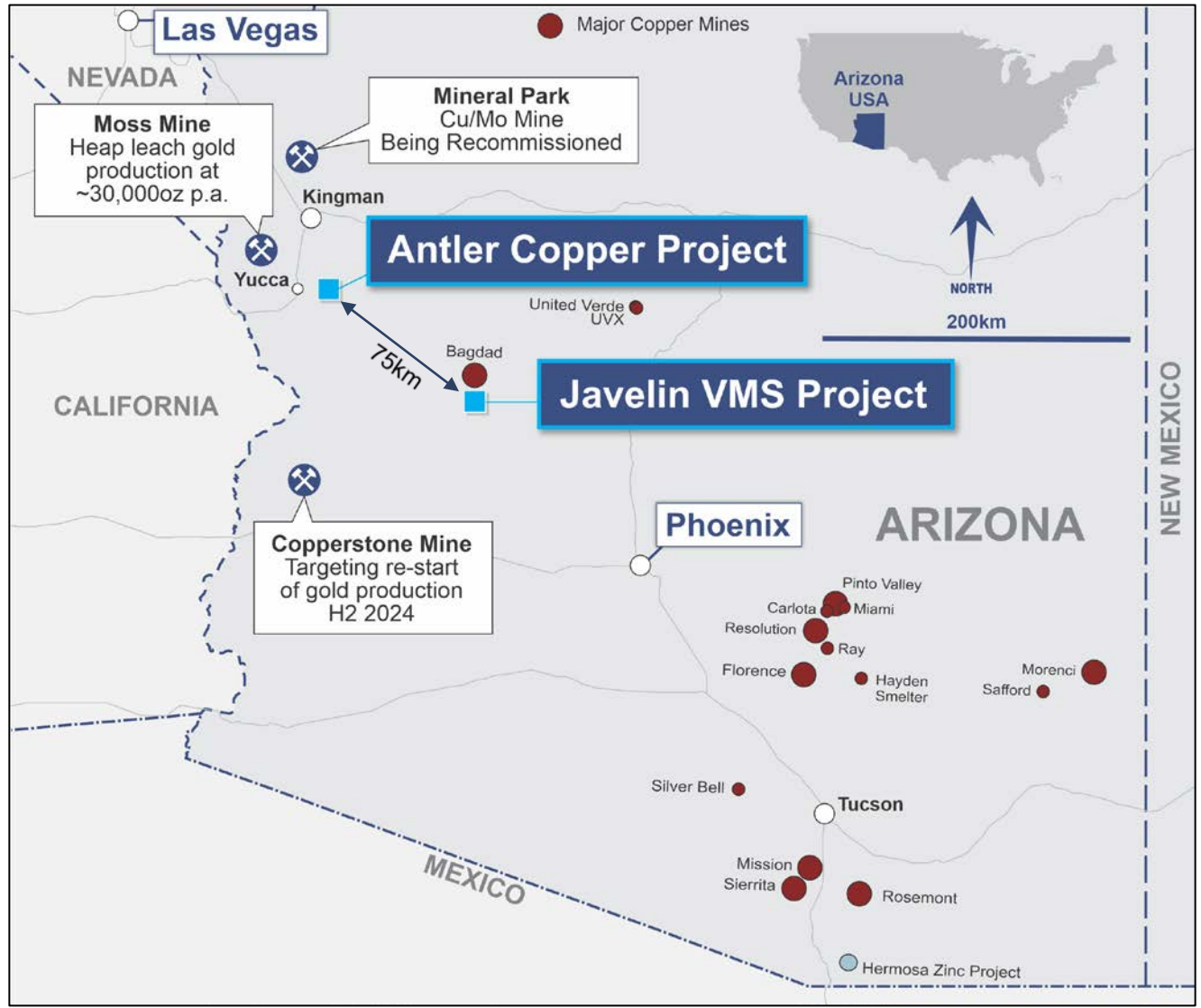

Antler Copper Project – Prior to NWC: No Work Since 1975

Historical Production 1916-1970

70,000t @ 2.9% Cu, 6.2% Zn, 1.1% Pb, 31 g/t Ag & 0.3 g/t Au

5.0% Cu-equivalent

A VMS Deposit

No work since 1975

NWC commenced work in March 2020

NWC took 100% ownership in Oct. 2021

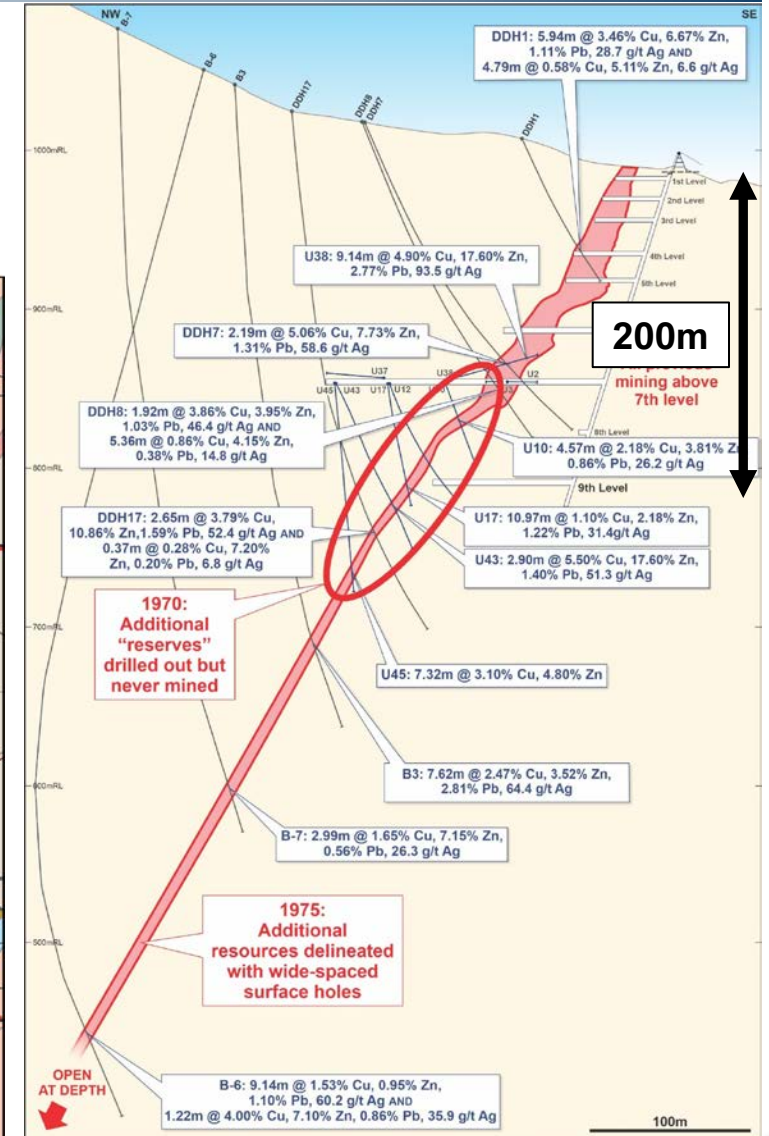
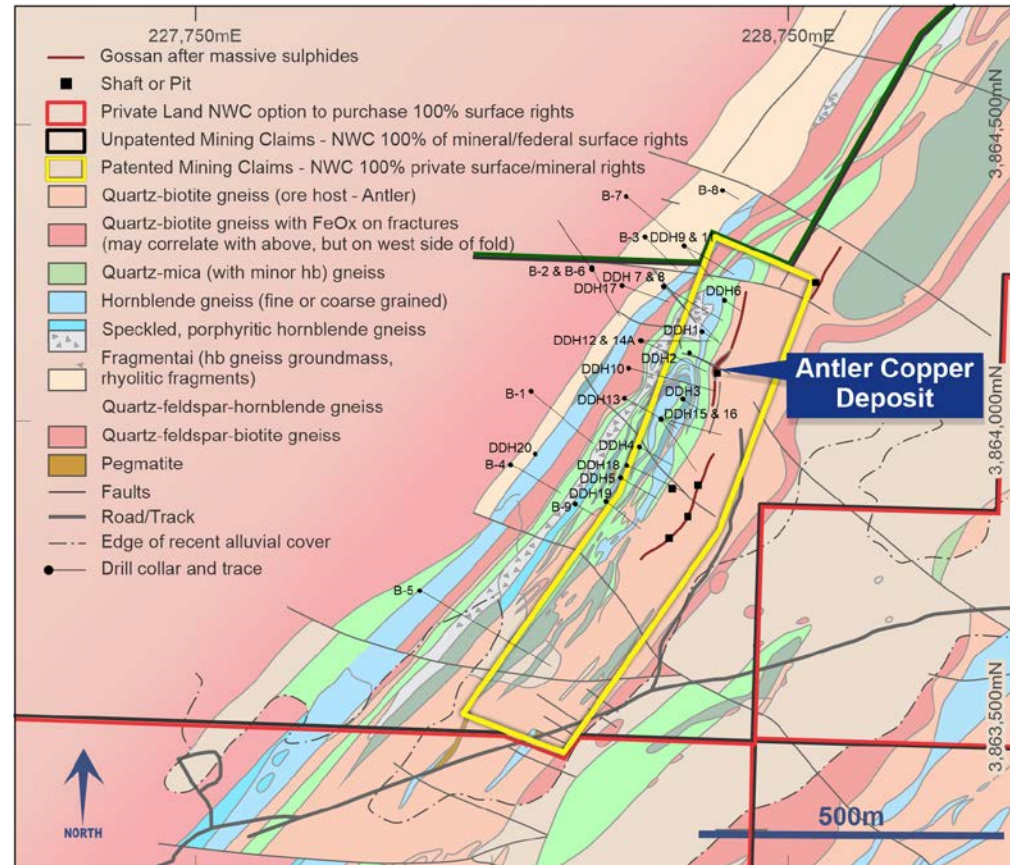



Very High-Grade Resource

New World has drilled >130 holes for >58,000m
 JORC Mineral Resource Estimate (Nov. 2022):

At a 1.0% Cu-Equiv. cut-off
11.4Mt @ 2.1% Cu, 5.0% Zn, 0.9% Pb, 32.9 g/t Ag and 0.36 g/t Au
 (11.4Mt @ 4.1% Cu-equivalent*)
 79% classified "Indicated"

At a 2.0% Cu-Equiv. cut-off
9.8Mt @ 2.4% Cu, 5.6% Zn, 0.9% Pb, 34.3 g/t Ag and 0.35 g/t Au
 (9.8Mt @ 4.5% Cu-equivalent*)

Nov. 2022 Resource was incorporated into an Updated Scoping Study – with results announced in May 2023

*Cu equiv. (%) = (Cu% x 0.872) + (Zn% x 0.889 x 3,011/7,507) + (Pb% x 0.591 x 2,116/7,507) + (Ag oz/t x 0.503 x 20.26/7,507 x 100) + (Au oz/t x 0.700 x 1,709/7,507 x 100). Refer ASX Announcement 28 November 2022.

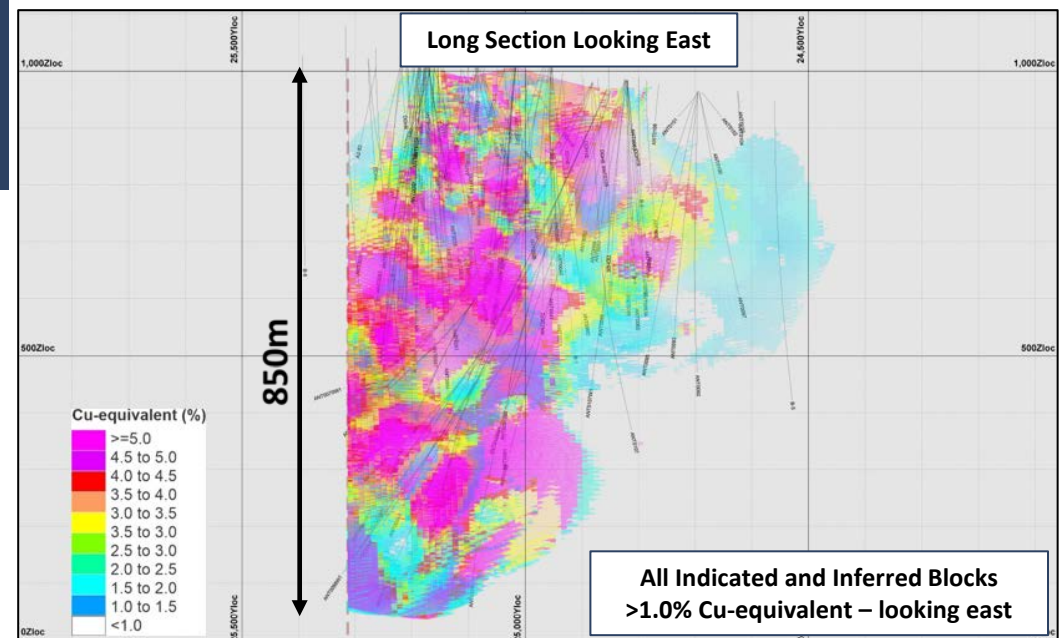
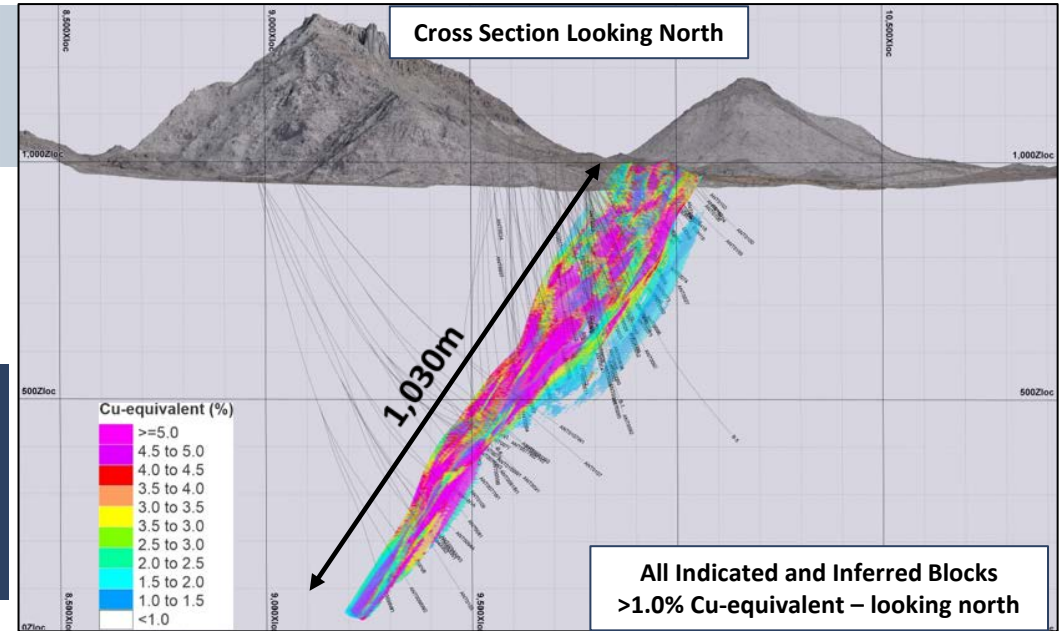



Antler Copper Project – Environmentally and Socially Responsible Development Approach

Underground Mining Only (No Open Pit).

Dry-Stack Filtered Tailings.

~50% of Tailings To Be Used As Underground Fill.

Almost All Infrastructure On Privately-Owned Land.

Comparably Low Carbon Emissions

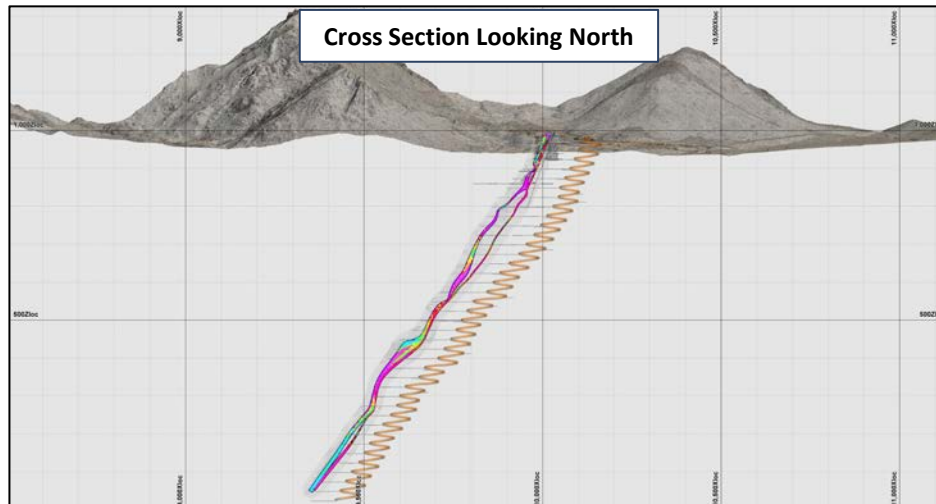
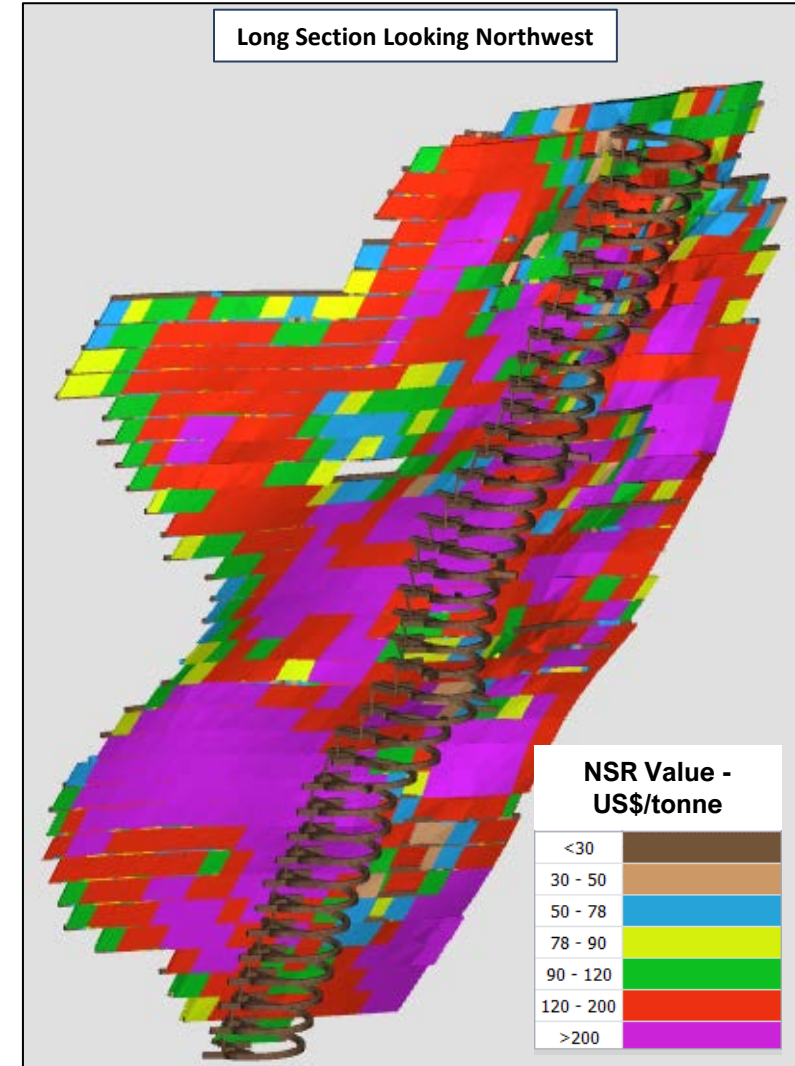



Excellent Location and Infrastructure = Low CAPEX & Low OPEX

15km from Rail

15km from Interstate Highway

Power within 750m of Headframe

55km from 30,000 people

Cheap to Build

Cheap to Operate

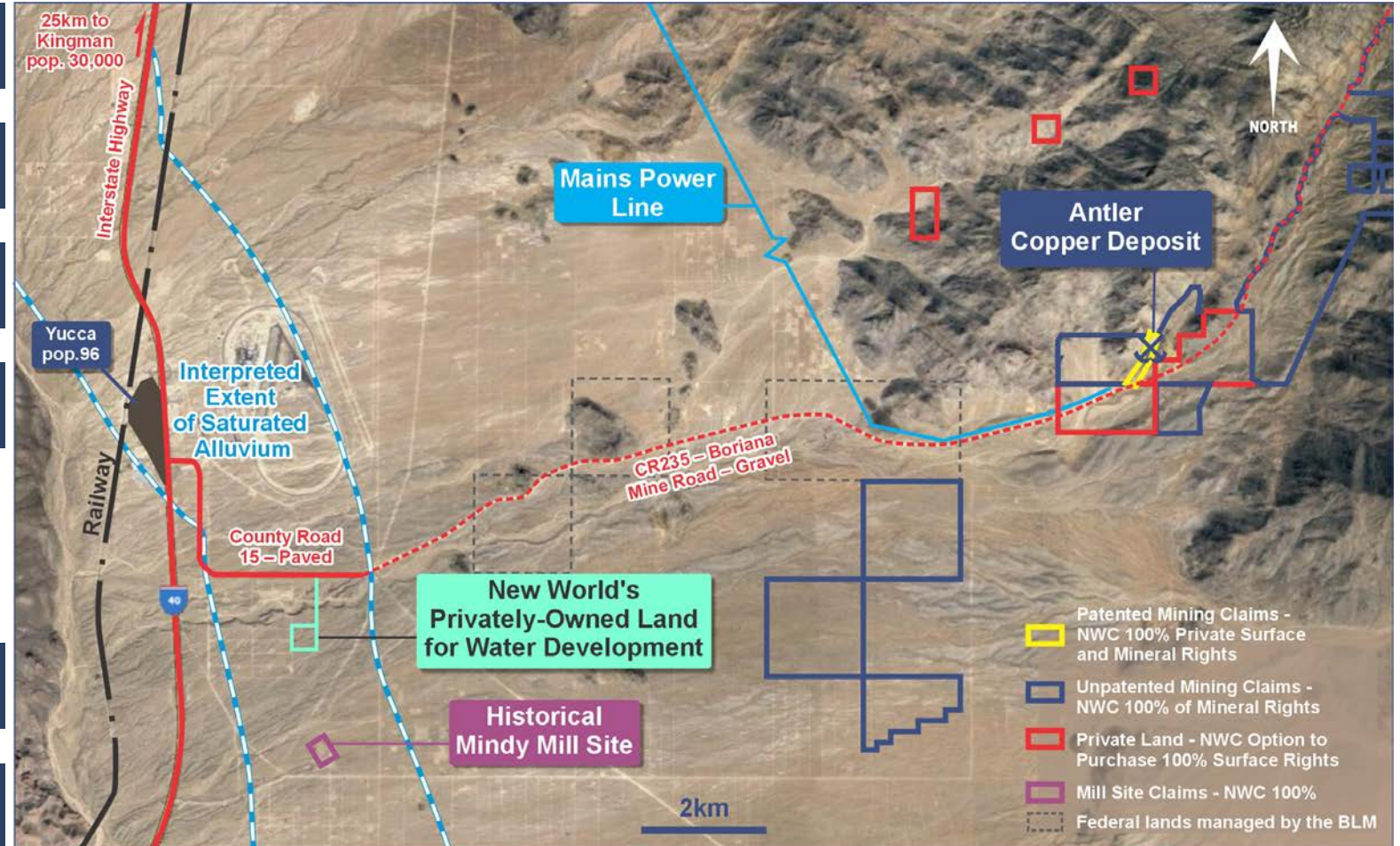



2023 Scoping Study: Site Layout

All Mining Infrastructure on Private Land

Simplifies and streamlines mine permitting

Processing Plant Location Enables Staged Expansion

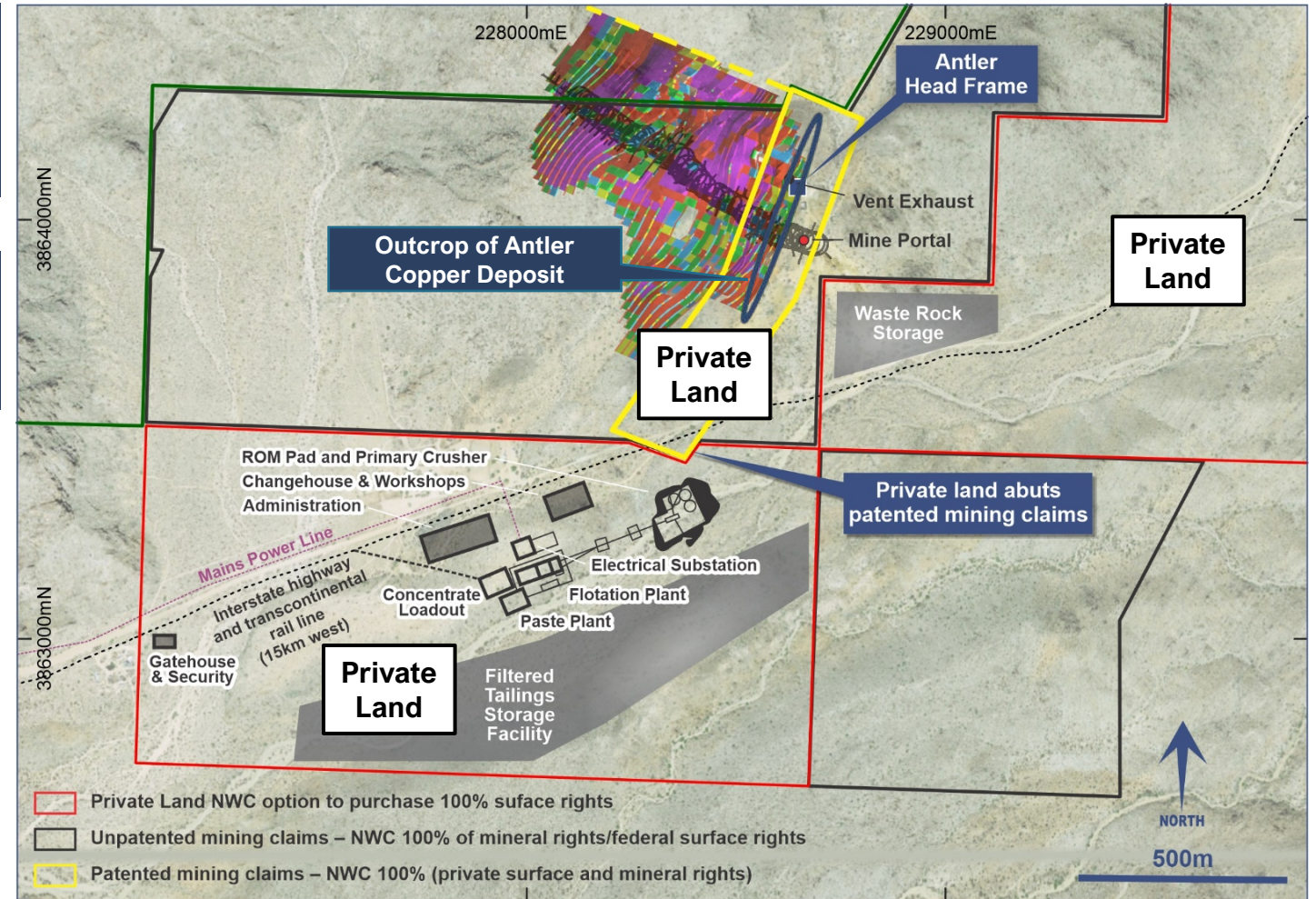

2023 Scoping Study Outcomes

15.4Mt Mined – 1.3Mtpa for 13 Year Mine Life

Pre-Production CAPEX: US\$252m

Including US\$44.m Contingency
Assumes Contractor Mining
Additional US\$70.2m Sustaining Capital

NSR Revenue: US\$194/tonne

AISC Cost¹: US\$96.49/tonne

Average Annual Production: 32,700t Cu-Equiv.
including 16,400t Copper

C1 Cost – Copper-Equivalent Production
US\$1.68/lb (US\$3,703/tonne)

C1 Cost – Copper-Only Production (Net of Co-Product Credits)
Negative US\$0.50/lb (Negative US\$1,102/tonne)

¹AISC includes C1 cash costs plus sustaining capital, closure cost and salvage value

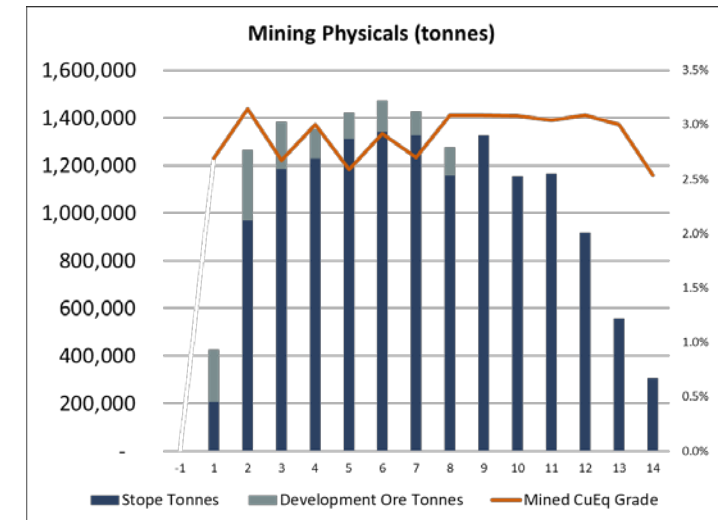

US\$252m Pre-Production Capital (US\$m)

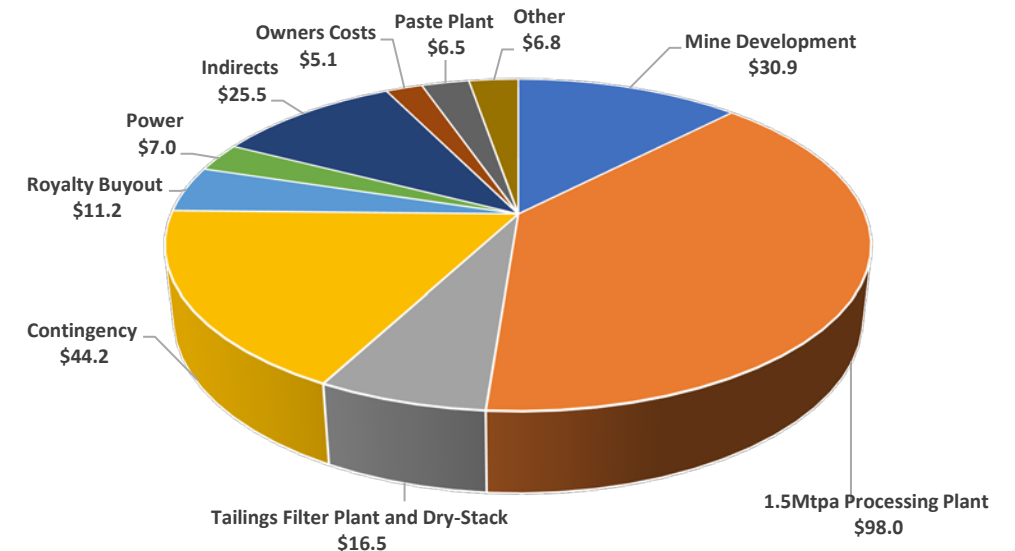



2023 Scoping Study: Free Cash Flow, NPV, IRR

Initial Operating Life

A\$3.0bn Revenue

A\$4.3bn

Initial Operating Life

US\$1.5bn Free Cash Flow

A\$2.15bn (undiscounted, pre-tax)

Average Over 10yrs at Steady-State

US\$153m Annual Free Cash Flow

A\$219m/year (pre-tax)

Viability

NPV₇ US\$835m

A\$1.25bn (pre-tax)

Viability

IRR 40.2% Pre-tax

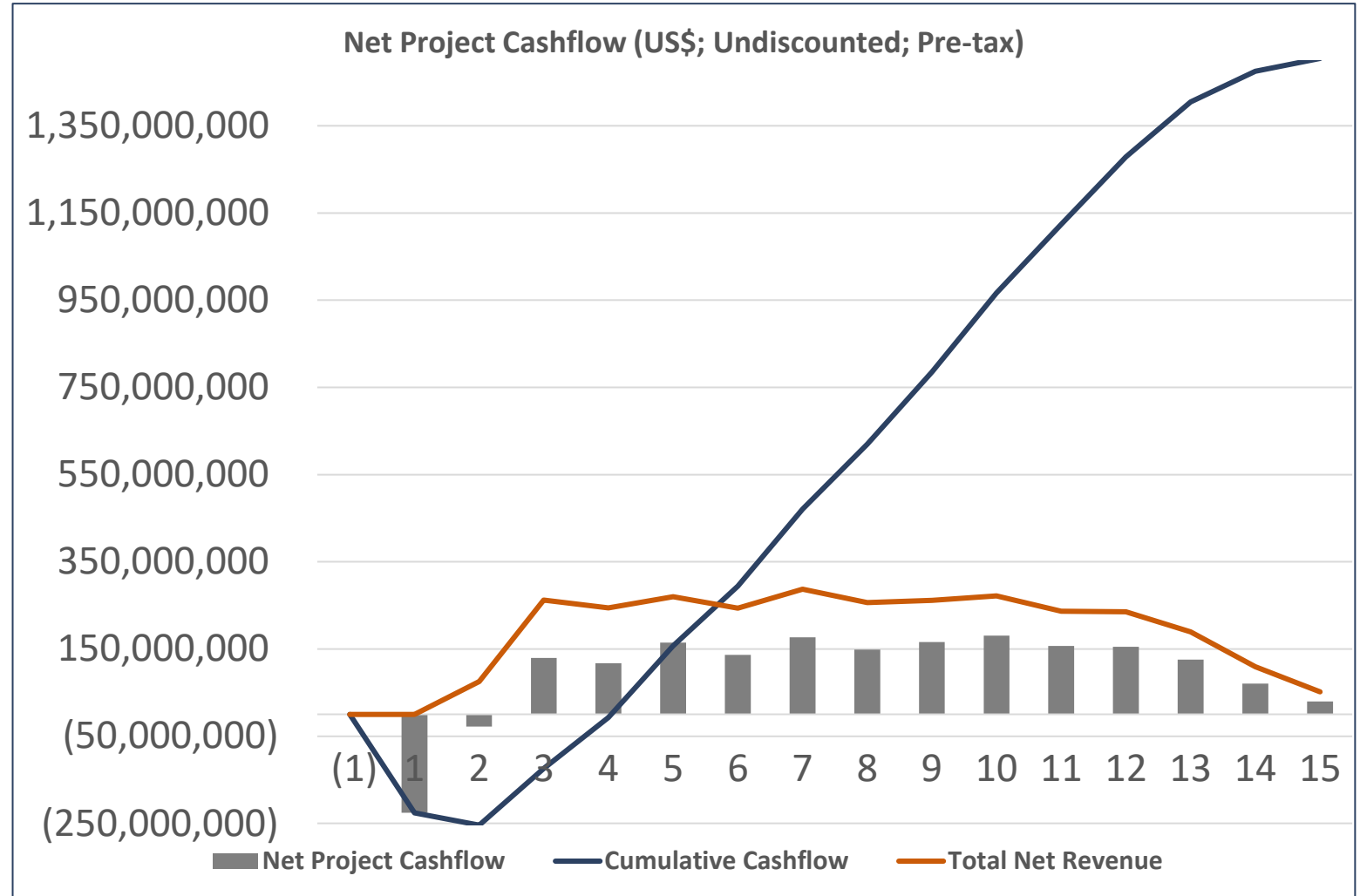



2023 Scoping Study: Total Metal Production

Initial Operating Period

381,400t Cu-Equiv.

Initial Operating Period

190,000t Copper

Initial Operating Period

444,500t Zinc

Initial Operating Period

61,000t Lead

Initial Operating Period

7,723,000 oz Silver

Initial Operating Period

57,400 oz Gold

US\$ Revenue by Metal

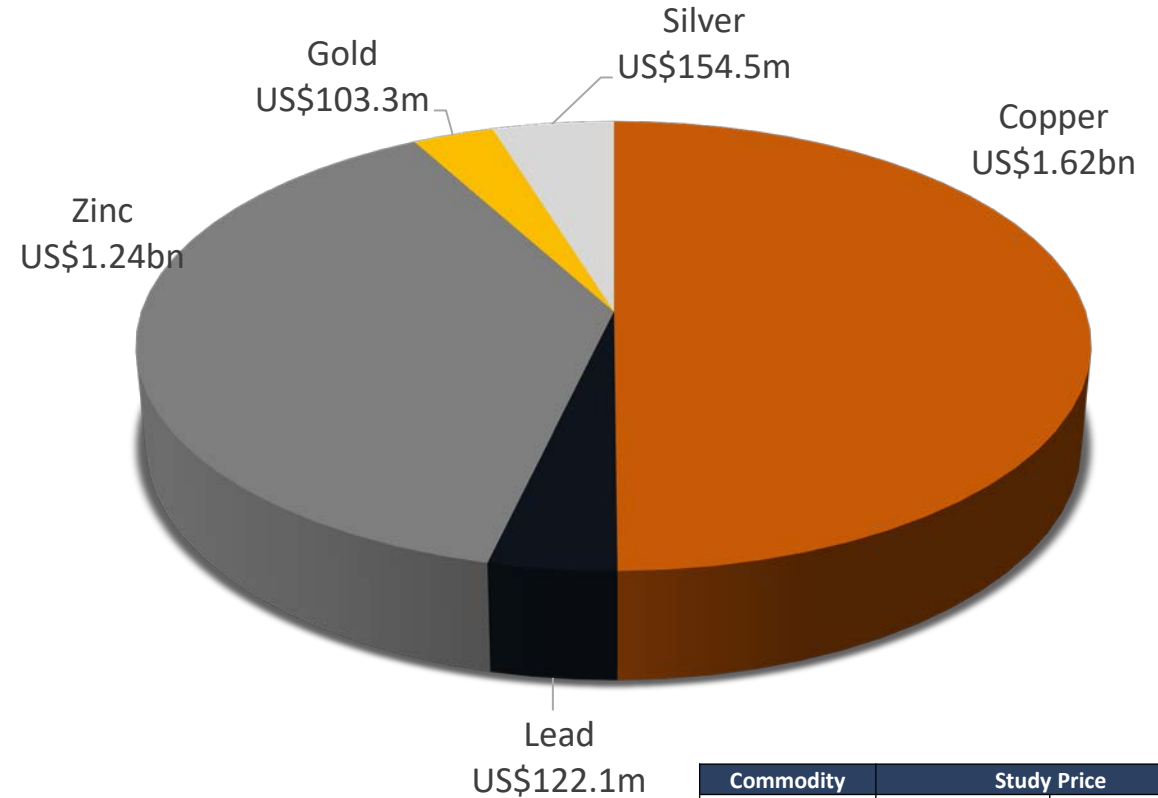

Commodity	Study Price	
Copper	US\$8,500/t	US\$3.85/lb
Zinc	US\$2,800/t	US\$1.27/lb
Lead	US\$2,000/t	US\$0.91/lb
Silver	US\$20/oz	
Gold	US\$1,800/oz	

- US\$258m of revenue from precious metals - Potential source of financing

Refer Slide 3 for Cautionary Statement on Inferred Resources



Compelling Resource Expansion Potential – Including Seven High-Priority Untested Drill Targets

At Depth at the Antler Deposit

1,500m+ Cu-Soil Anomaly at Antler

New Mineral Rights Immediately South of the Antler Deposit

4 IP/Geochemistry Anomalies Over >6km Along Strike From the Antler Deposit

Potential Satellite Deposits – Javelin VMS Project

Drilling recommenced in mid-October 2023:

- 3 holes being drilled for hydrology then onto exploration drilling





Antler Deposit – Open at Depth

- NWC has completed 58,000m of drilling to date.
- Exceptional assay results Cu returned from deeper drilling include:

Main Shoot
41.8m @ 3.8% Cu-equiv.)
2nd best hole drilled

Main Shoot
10.2m @ 6.2% Cu-equiv.)

South Shoot
27.0m @ 7.0% Cu-equiv.)
Best hole drilled

Main Shoot
18.2m @ 3.4% Cu-equiv.)

South Shoot
10.7m @ 13.7% Cu-equiv.)
Deepest hole in South Shoot
(Results not included in updated JORC Resource)

Main Shoot
21.3m @ 5.3% Cu-equiv.)
Deepest hole drilled

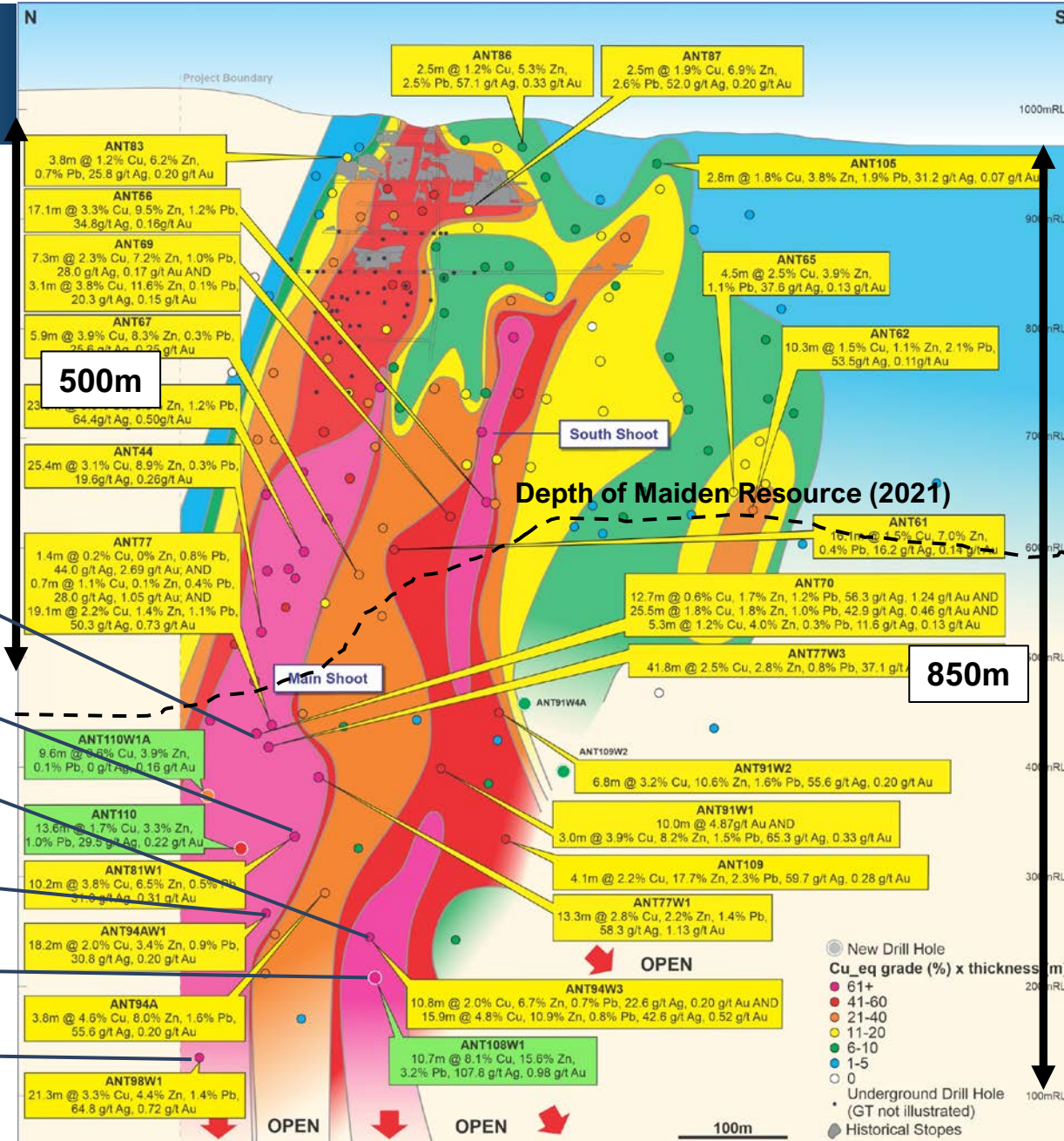



Exploration Potential - Strike Extensions of Antler Deposit

All drilling to date over ~600m of strike at the Antler Deposit

1,500m-long copper-in-soil anomaly

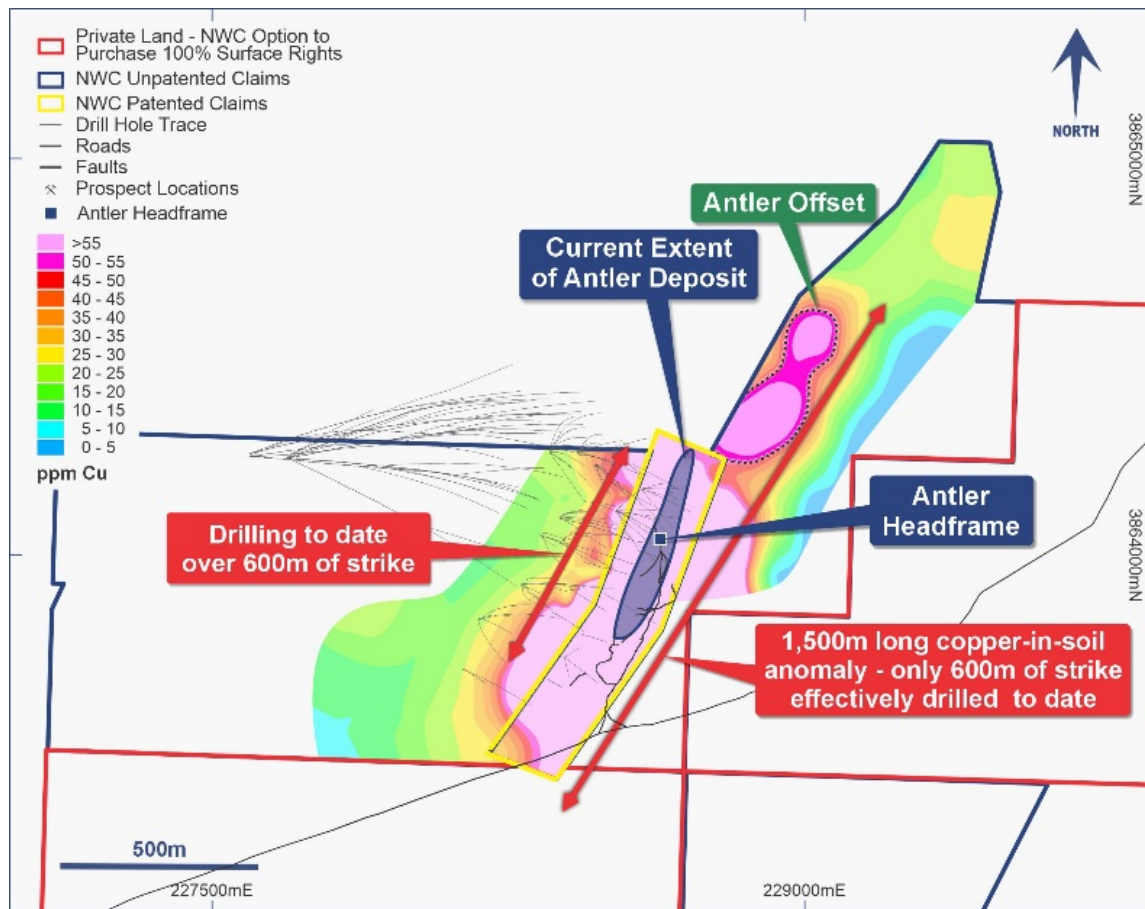

2,000m-long zinc-in-soil anomaly

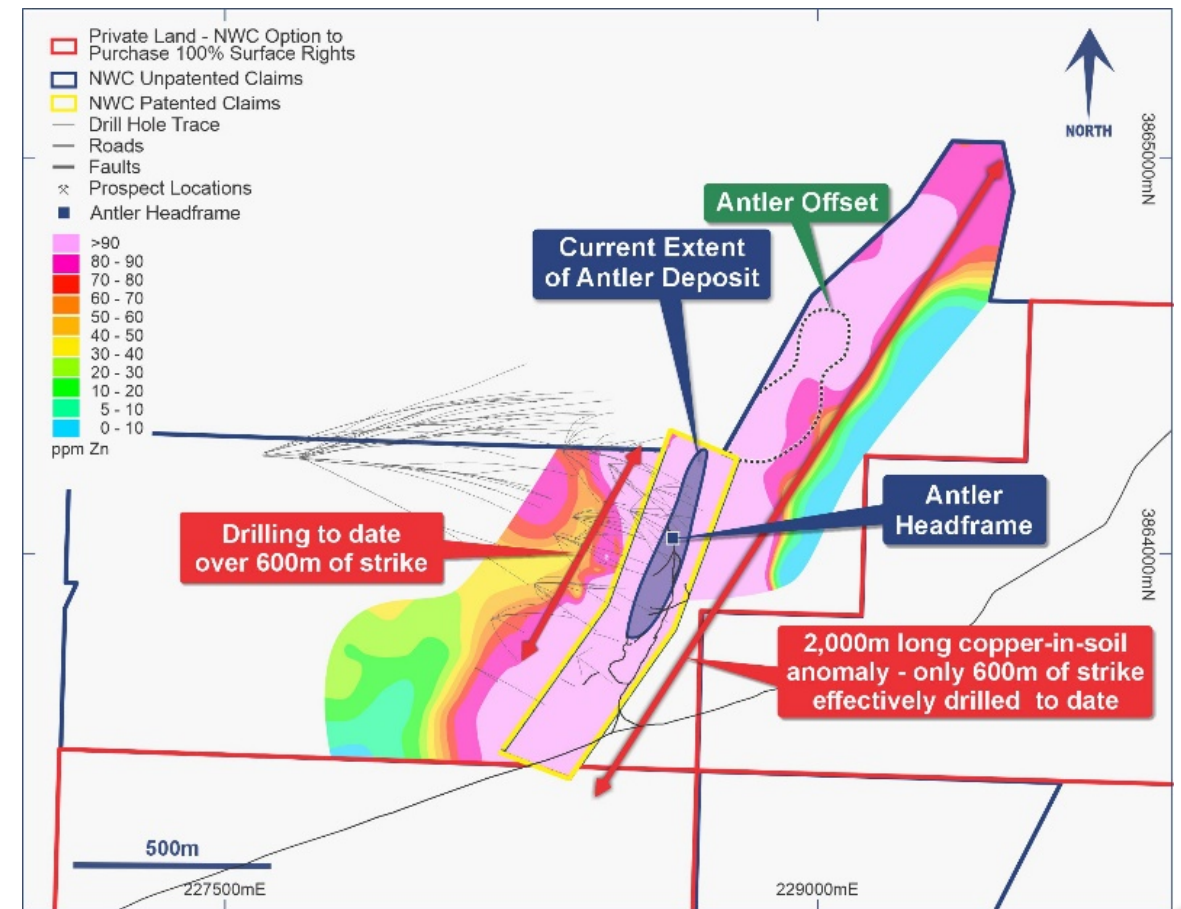

New Mineral Rights Immediately Along Strike from Antler

Agreed to Purchase 1,000 Acres of Mineral Rights Immediately Along Strike From the Antler Deposit

JORC Resource Block Model <150m From Boundary

Strong Copper and Zinc Geochemical Anomalies To the Boundary

No Previous Drilling Within the New Areas

Soil Geochemistry, Aeromagnetics and IP Surveying Commencing Imminently

Private Land & Drill Rig On Site = Rapid Drill Testing

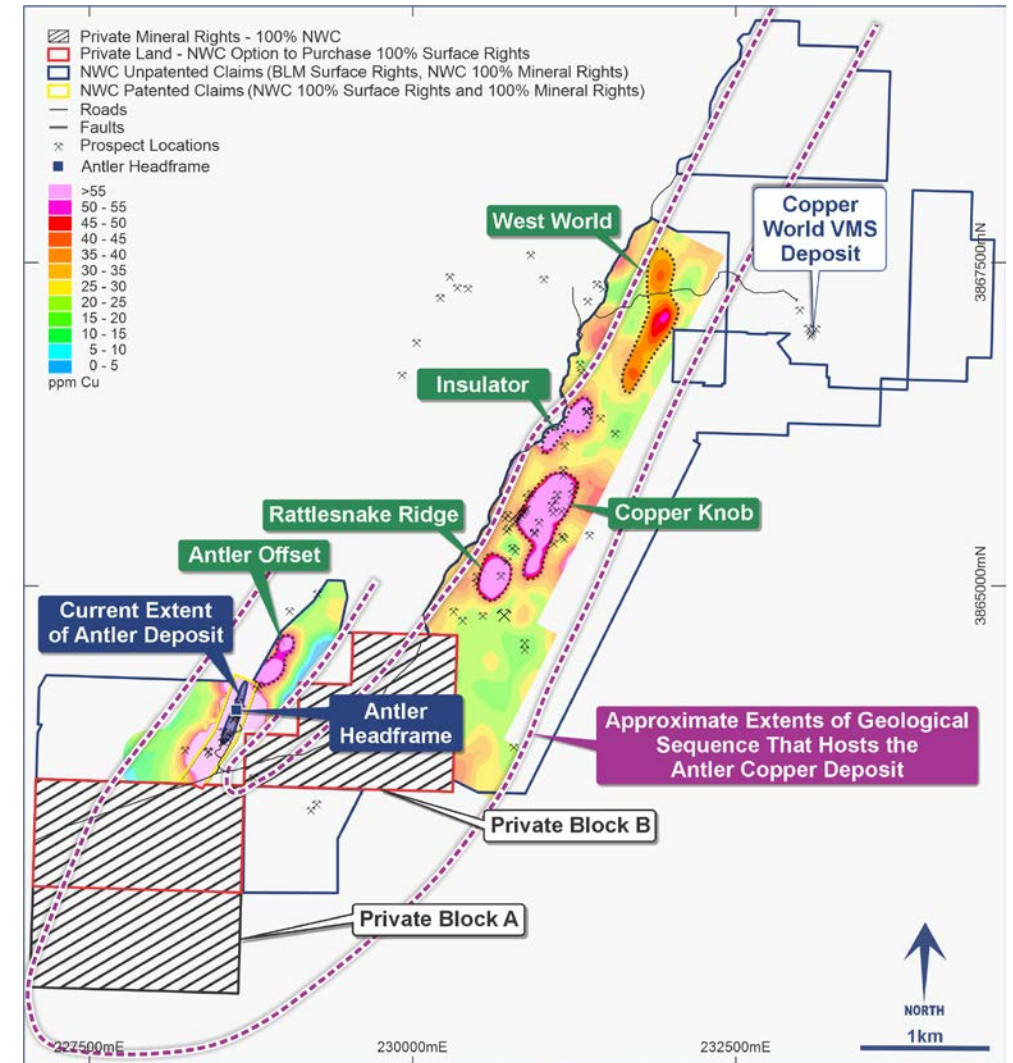

Plan View - Copper in Soil Geochemistry



Undrilled Geochemical/Geophysical Targets Along Strike from Antler

No previous drilling between Antler and Copper World

Four look-a-like IP/geochemistry targets over 6km of strike

Orthogonal View – IP Chargeability Anomalies

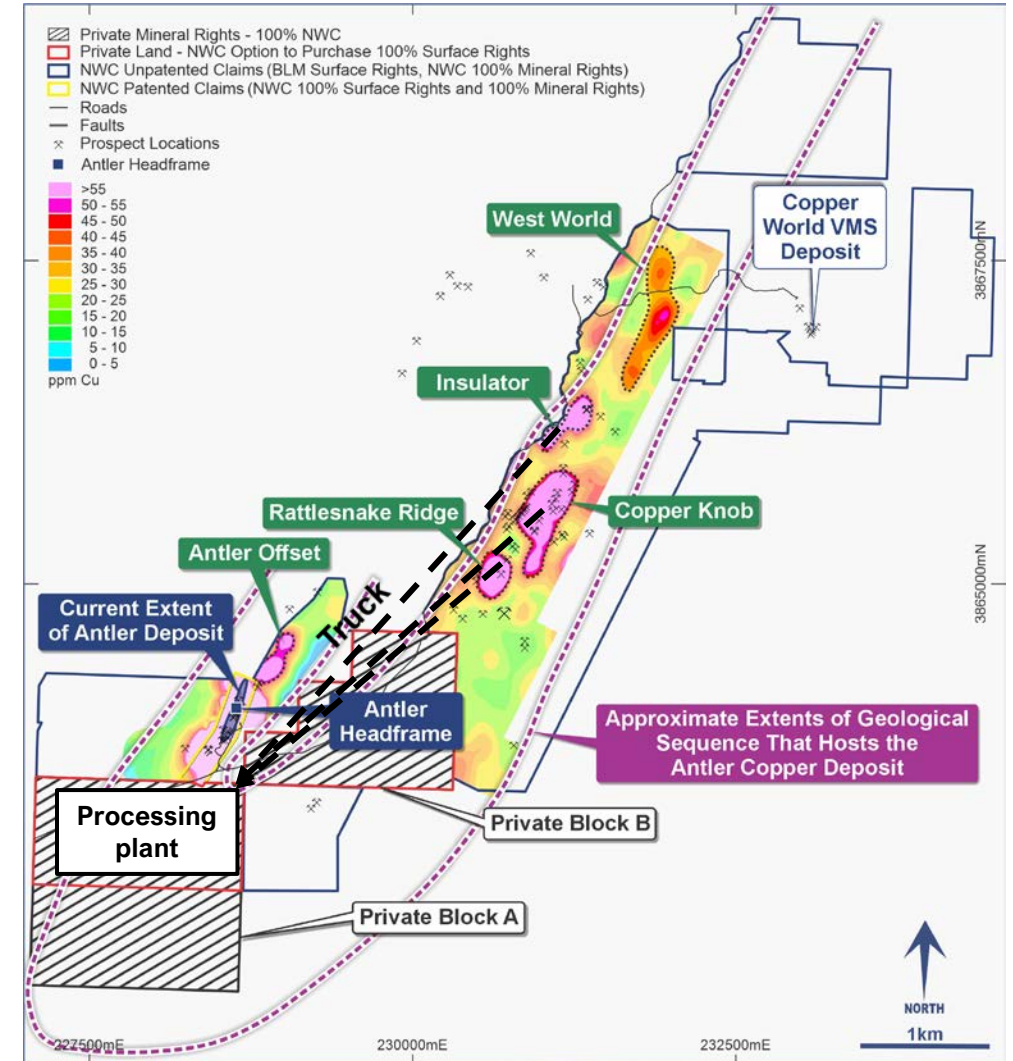
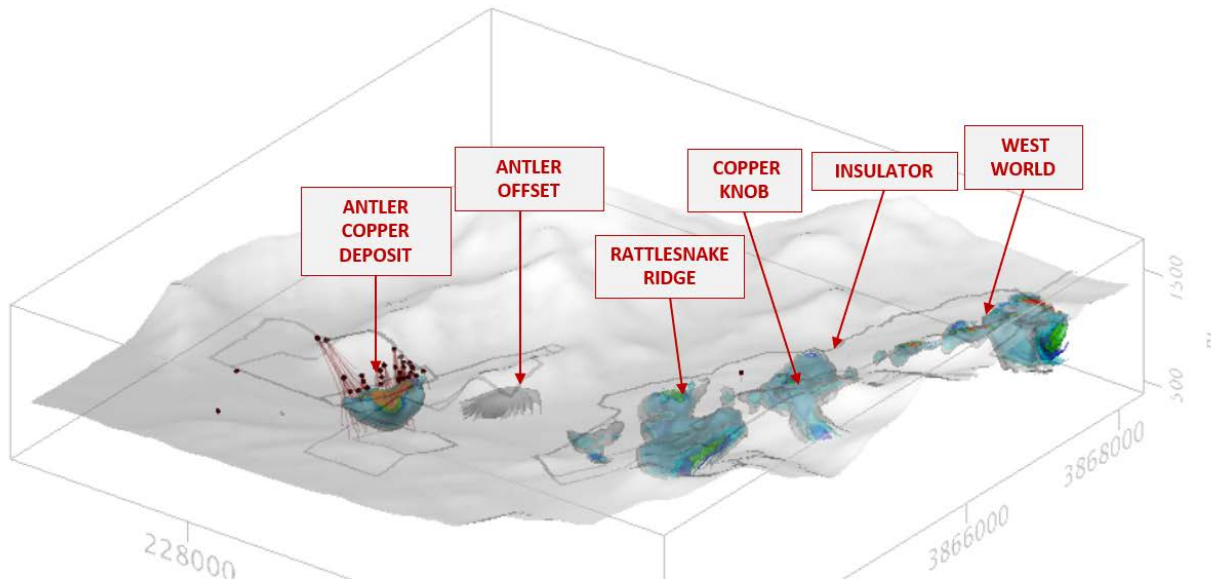

Plan View – Copper in Soil Geochemistry



Javelin Project, Arizona – 75km SE of Antler

- 100%-owned BLM mining claims covering >4,000 acres.

Proven VMS District

- Old Dick Mine - 614,000 tonnes @ 3.36% Cu and 10.6% Zn mined 1943-1965
- Bruce Mine - 746,000 tonnes @ 3.65% Cu and 12.7% Zn mined 1968-1977
- Pinafore Deposit - ~635,000 tonnes @ 3.4% Cu and 7.1% Zn historic resource

World-Class Porphyry Copper Deposit

- Bagdad Copper Mine – reserves of 2.6Bt @ 0.33% Cu and 0.02% Mo
- Ore from satellite deposits could be mined and trucked to the proposed processing plant at Antler.

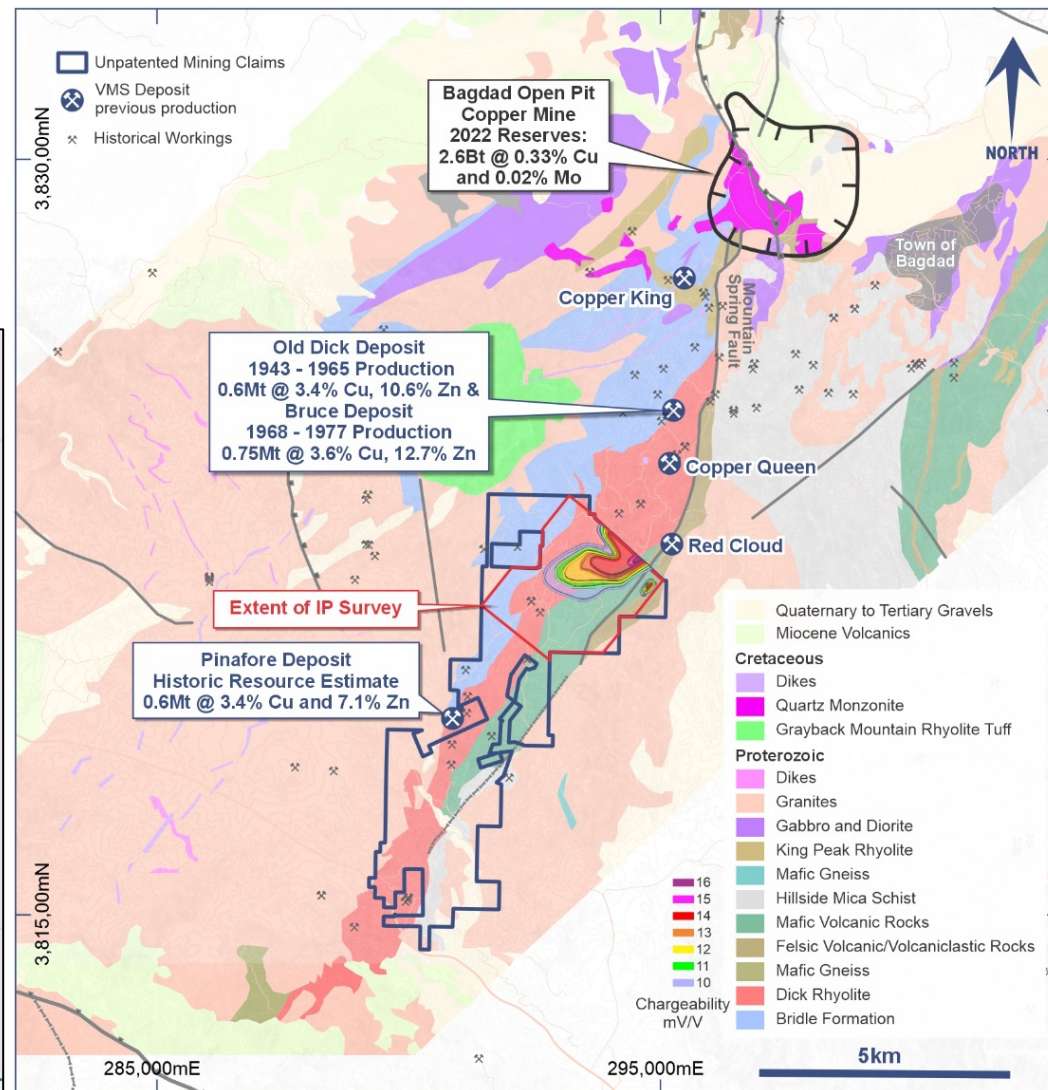
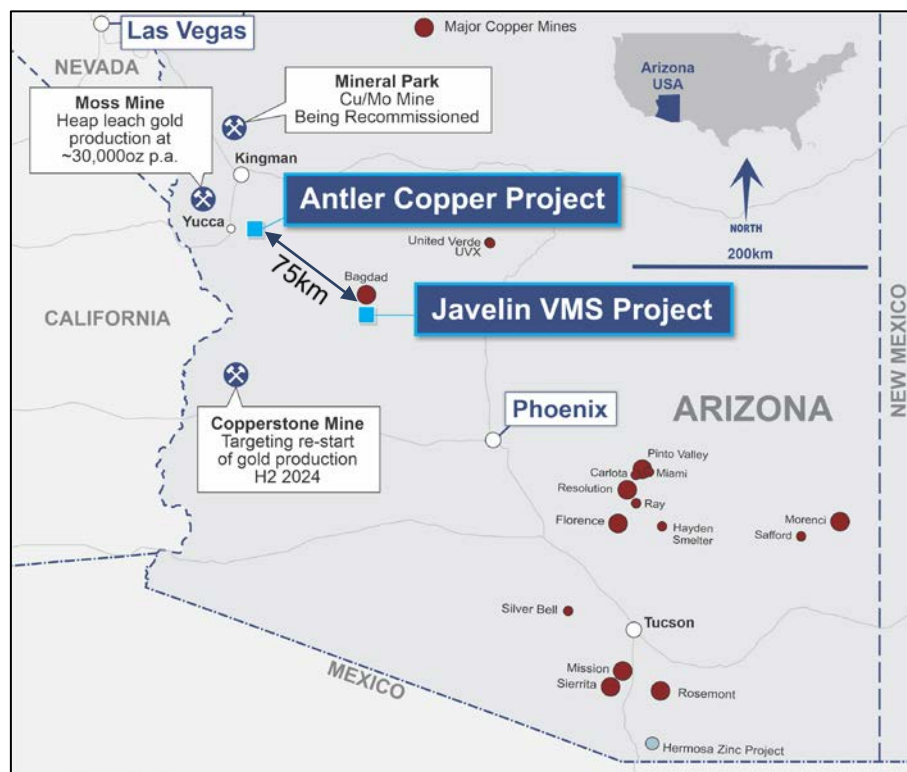

Javelin VMS Project, Arizona, USA

- Extensive, strong multi-element soil anomalies defined in May 2023.
- Exceptional 1.2km x 1.0km IP anomaly defined in July 2023.
- Extensive outcropping mineralisation above IP anomaly – to 15.0% Cu, 3.5% Zn, 180 g/t Ag and 2.14 g/t Au.
- Maiden drilling program to commence late Q4 2023/early 2024.

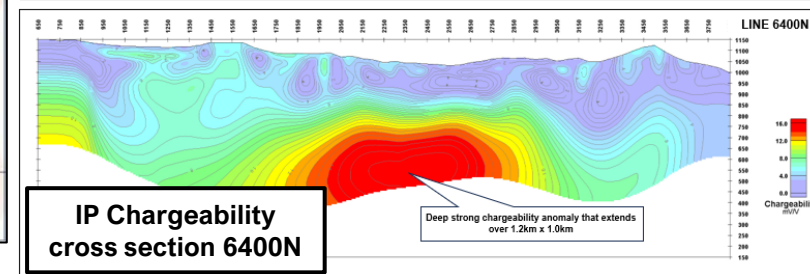
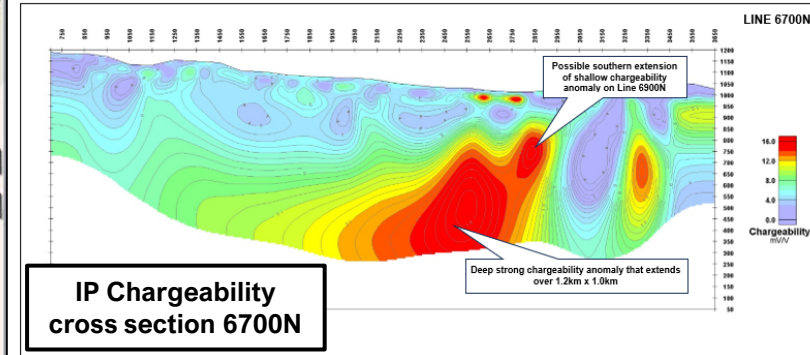
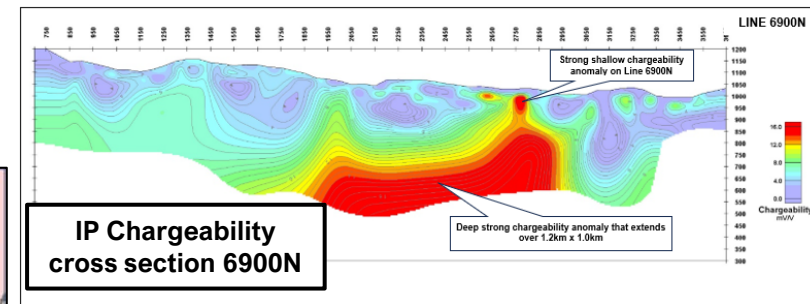
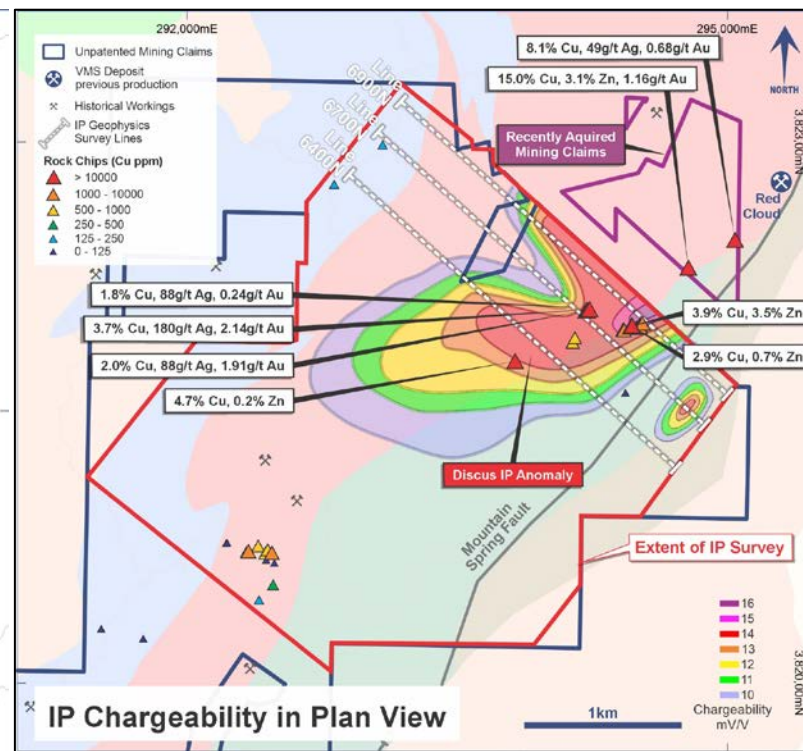
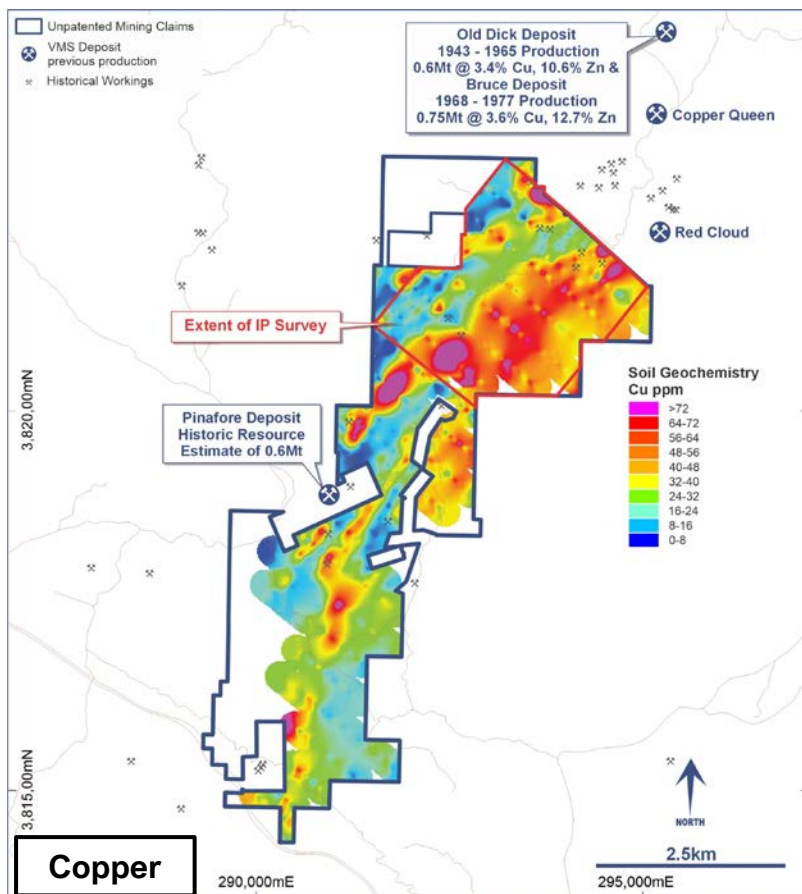



Forward Work Program – Antler Copper Project

Work Program	2023				2024				2025			
	Q1	Q2	Q3	Q4	Q1	Q2	Q3	Q4	Q1	Q2	Q3	Q4
Exploration Drilling - Resource Expansion	■			■	■	■	■	■	■	■	■	■
Updated Scoping Study		■										
Pre-Feasibility Study		■	■	■								
Federal Mine Permit Approval				■	■	■	■	■	■	■	■	■
State Mine Permit Approvals				■	■	■	■	■	■	■		
Definitive Feasibility Study				■	■	■	■	■	■			
Pre-Construction Development (Decline)									■	■	■	■



Antler Copper Project – Set For Success

Excellent Jurisdiction

Very High-Grade Mineralisation

Modest CAPEX

High Margin

Long Life

Near-Term Production

Considerable Exploration Potential





Previously Reported Results and Contact Details

Previously Reported Results

There is information in this presentation relating to:

(i) the updated Mineral Resource Estimate for the Antler Copper Deposit, which was previously announced on 28 November 2022, and the initial Mineral Resource Estimate announced on 5 November 2021; and

(ii) exploration results which were previously announced on 14 January, 9 and 20 March, 17 and 24 April, 12 May, 3 June, 7, 21 and 28 July, 3 and 31 August, 22 September, 22 October and 2 and 10 and 25 November 2020 and 18 January and 2, 12 and 19 March and 8 and 20 April, 20 May, 21 June, 15 and 29 July, 16 August, 22 September, 13 October, 1, 5 and 30 November 2021 and 20 January, 1 March, 20 April, 14 and 22 July, 26 September, 4 and 11 October, 23 November and 5 December 2022 and 7 and 13 June, 31 July, 20 October and 9 November 2023.

Other than as disclosed in those announcements, the Company confirms that it is not aware of any new information or data that materially affects the information included in the original market announcements, and that all material assumptions and technical parameters have not materially changed. The Company also confirms that the form and context in which the Competent Person's findings are presented have not been materially modified from the original market announcements.

All references to the 2022 Scoping Study and its outcomes in this document relate to the announcement of 11 July 2022 titled "Scoping Study Results – Antler Copper Project". Please refer to that announcement for full details and supporting information.

All references to the 2023 Scoping Study and its outcomes in this document relate to the announcement of 2 May 2023 titled "Enhanced Scoping Study – Antler Copper Project". Please refer to that announcement for full details and supporting information.

For further information contact:

Mike Haynes – Managing Director/CEO

New World Resources Limited

mhaynes@newworldres.com

+61 419 961 895

www.newworldres.com



Forward Looking Statements

Information included in this presentation constitutes forward-looking statements. When used in this presentation, forward-looking statements can be identified by words such as “anticipate”, “believe”, “could”, “estimate”, “expect”, “future”, “intend”, “may”, “opportunity”, “plan”, “potential”, “project”, “seek”, “will” and other similar words that involve risks and uncertainties.

Forward-looking statements inherently involve known and unknown risks, uncertainties and other factors that may cause the Company’s actual results, performance and achievements to differ materially from any future results, performance or achievements. Relevant factors may include, but are not limited to, changes in commodity prices, foreign exchange fluctuations and general economic conditions, increased costs and demand for production inputs, the speculative nature of exploration and project development, including the risks of obtaining necessary licences and permits and diminishing quantities or grades of resources and reserves, political and social risks, changes to the regulatory framework within which the Company operates or may in the future operate, environmental conditions including extreme weather conditions, recruitment and retention of personnel, industrial relations issues and litigation as well as other uncertainties and risks set out in the announcements made by the Company from time to time with the Australian Securities Exchange.

Forward-looking statements are not guarantees of future performance and involve known and unknown risks, uncertainties, assumptions and other important factors, many of which are beyond the control of the Company, its directors and management of the Company that could cause the Company’s actual results to differ materially from the results expressed or anticipated in these statements.

The Company cannot and does not give any assurance that the results, performance or achievements expressed or implied by the forward-looking statements contained in this announcement will actually occur and investors are cautioned not to place undue reliance on these forward-looking statements. The Company does not undertake to update or revise forward-looking statements, or to publish prospective financial information in the future, regardless of whether new information, future events or any other factors affect the information contained in this announcement, except where required by applicable law and stock exchange listing requirements.



Appendix 1 – Antler Project Acquisition Terms

- NWC owns 100% of the Antler Copper Project
- The entity that vended the project to NWC is entitled to additional payments that comprise:
 1. Annual payments of US\$75k per year until the commencement of commercial production;
 2. Cash payments totaling US\$2m during the first 12 months of commercial production; and
 3. 10% Net Proceeds Interest after CAPEX is recovered in full – NWC can purchase this (or part thereof) for US\$10M at any time up until 8 March 2024, and thereafter an escalation factor of 12% per annum (from March 2024) will apply.



Appendix 2 – Trident Royalty Terms – Antler Copper Project

- \$11 million from Trident Royalties Plc in exchange for:
 - A 0.90% NSR royalty over the Antler Copper Deposit and surrounding, currently defined, exploration targets (“**Project Area Royalty**”); and
 - A 0.45% NSR royalty over any additional mineral rights New World acquires within 5km of the current extents of the Antler Copper Project (“**AOI Royalty**”);
- New World will retain the right to buy-back:
 - 0.3% of the Project Area Royalty, to reduce it from 0.90% to 0.60%, for \$9 million; and/or
 - 0.15% of the AOI Royalty, to reduce it from 0.45% to 0.30%, for \$4 million

at any time within three months of New World obtaining at least 75% of the funding required for the development and construction of the Antler Copper Project;

- Trident will have the right to match any royalty or streaming transaction associated with the Antler Copper Project up until 12 months following the declaration of commercial production at the Project.
- The agreement with Trident **does not** impose any royalty on New World’s other projects, including the Javelin VMS and Tererro Base Metals Projects.

Appendix 3 – 2023 Scoping Study: Sensitivity Analysis

- The Project isn't particularly sensitive to capital or operating costs.
- Most sensitive to changes in metal prices.

Variance >>	-20%	-10%	0	10%	20%
Operating Cost					
NPV ₇ (US\$m)	1,003	919	835	751	667
IRR (%)	47.6	43.9	40.2	36.6	33.0
Payback (months)	30	34	36	39	42
Capital Cost					
NPV ₇ (US\$m)	885	860	835	810	785
IRR (%)	47.6	43.6	40.2	37.2	34.7
Payback (months)	32	34	36	38	40
Metal Pricing (see Adjacent Table for Pricing)					
NPV ₇ (US\$m)	421	628	835	1,042	1,249
IRR (%)	25.2	32.9	40.2	47.1	53.8
Payback (months)	51	42	36	31	27

Metal Prices Used in Sensitivity Analysis (US\$/tonne)

% Change	-20%	-10%	Base Case	+10%	+20%
Cu	6,800	7,650	8,500	9,350	10,200
Pb	1,600	1,800	2,000	2,200	2,400
Zn	2,240	2,520	2,800	3,080	3,360

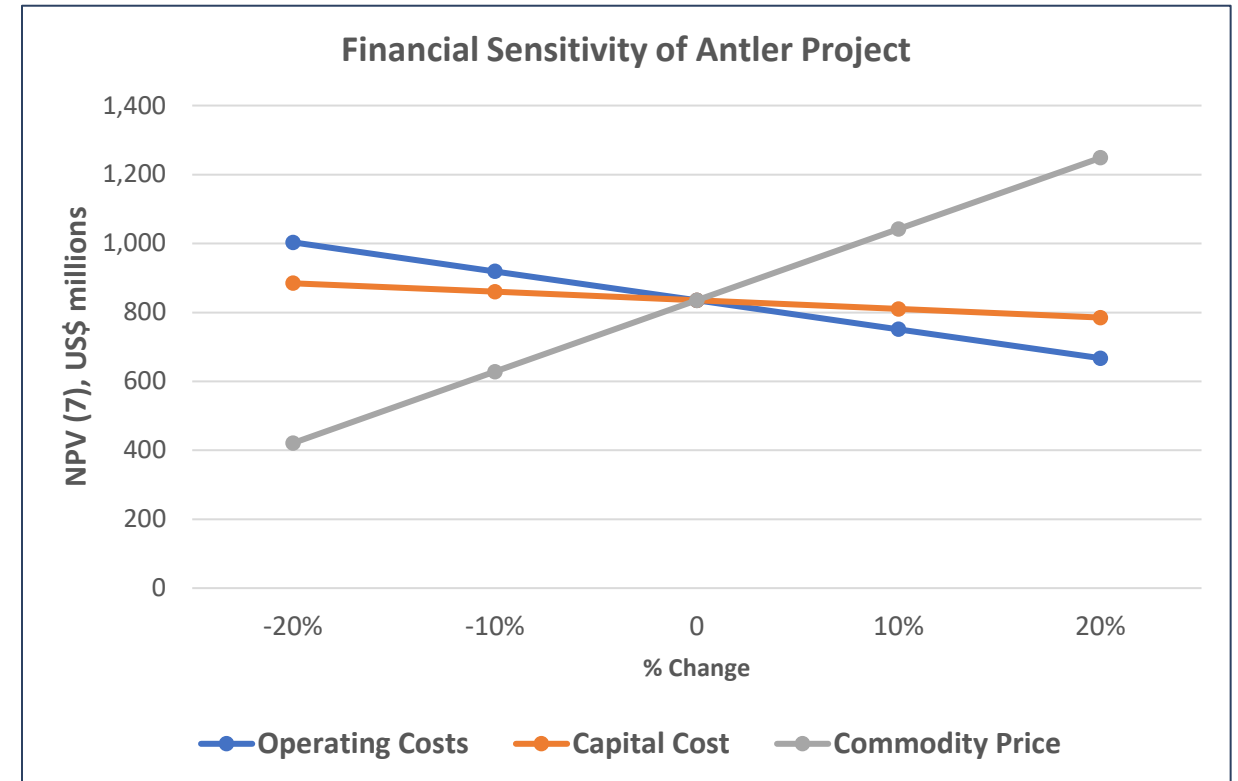



Appendix 4 – Mineral Resource Estimates For the Antler Copper Deposit

November 2022 JORC Mineral Resource Estimate for the Antler Copper Deposit above a 1.0% Cu-Equivalent cut-off grade (see NWC ASX Announcement dated 28 November 2022 for more information).

Classification	Tonnes	Cu (%)	Zn (%)	Pb (%)	Ag (g/t)	Au (g/t)	Cu-Equiv. (%)
Indicated	9,063,649	2.25	5.11	0.90	35.94	0.40	4.3
Inferred	2,371,673	1.55	4.46	0.85	21.32	0.17	3.3
Total	11,435,323	2.10	4.97	0.89	32.9	0.36	4.1

November 2022 JORC Mineral Resource Estimate for the Antler Copper Deposit above a 2.0% Cu-Equivalent cut-off grade (see NWC ASX Announcement dated 28 November 2022 for more information).

Classification	Tonnes	Cu (%)	Zn (%)	Pb (%)	Ag (g/t)	Au (g/t)	Cu-Equiv. (%)
Indicated	8,209,669	2.42	5.51	0.91	36.41	0.38	4.6
Inferred	1,588,114	2.02	5.83	0.87	23.16	0.19	4.2
Total	9,797,783	2.36	5.56	0.91	34.27	0.35	4.5



Appendix 5 – 2023 Scoping Study: Mine Development By Year

Year -1

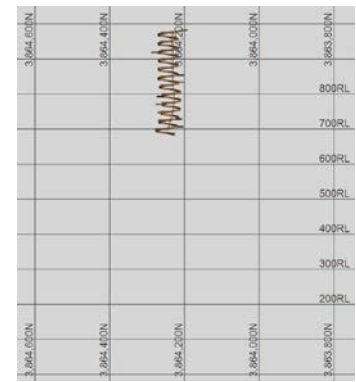

Year 1

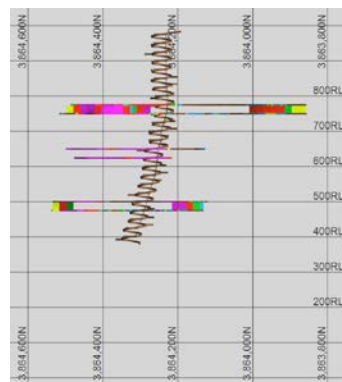

Year 2

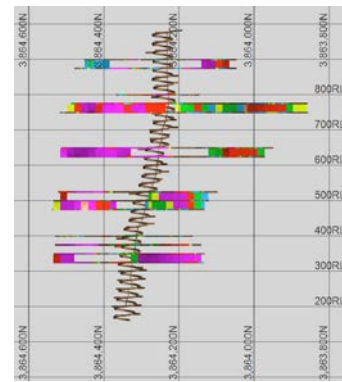

Year 3

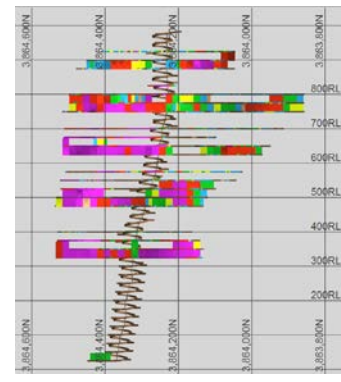

Year 4

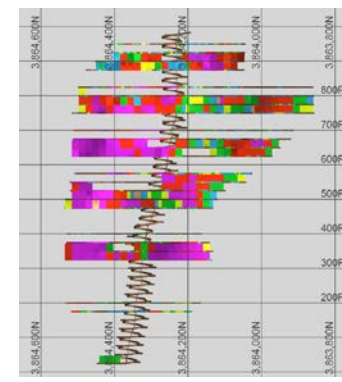

Year 5

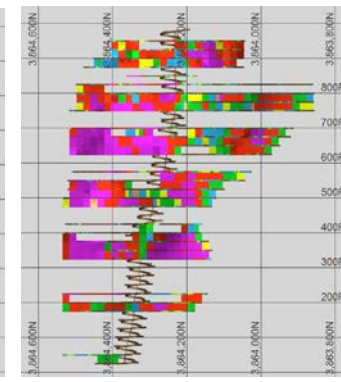

Year 6

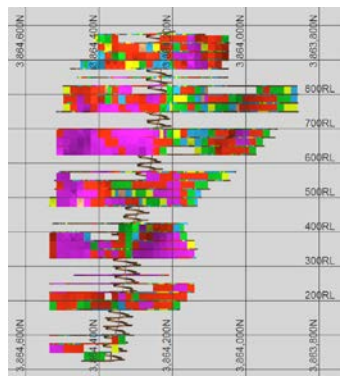

Year 7

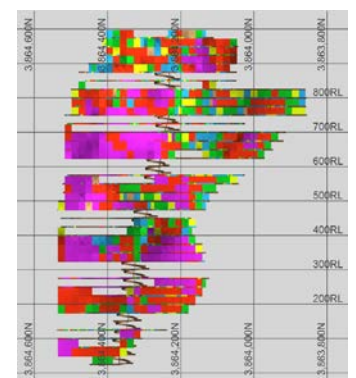

Year 8

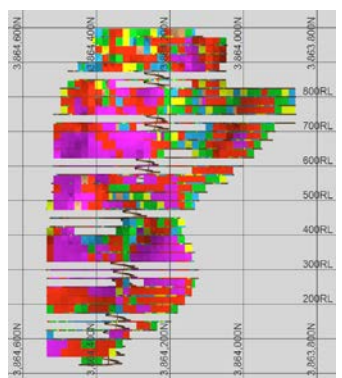

Year 9

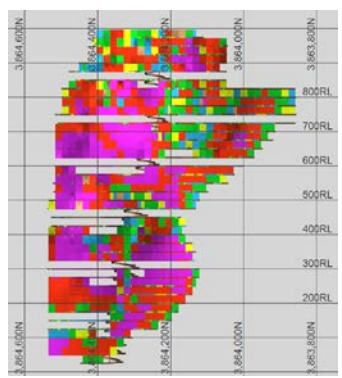

Year 10

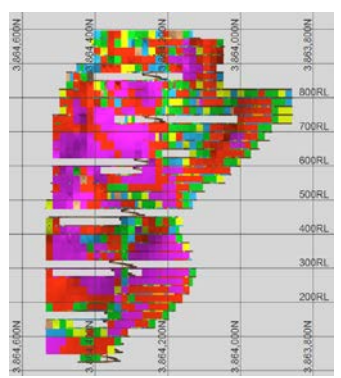

Year 11

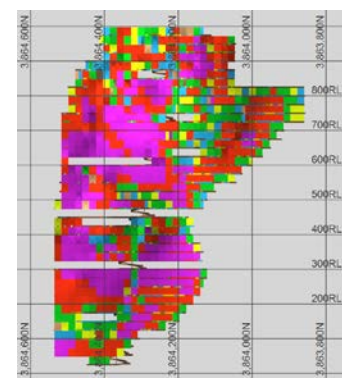

Year 12

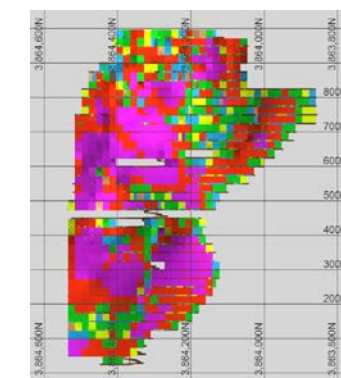

Year 13

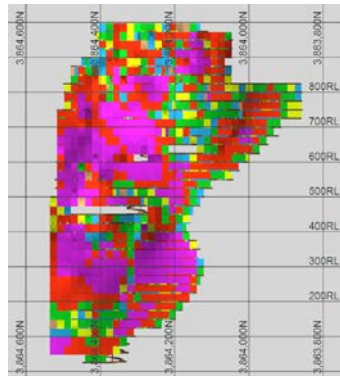

Appendix 6 – 2023 Scoping Study: Processing Flow Sheet

Primary grind:

- 80% passing 100 microns

Concentrate re-grind:

- 80% passing 35 microns

Produce 3 concentrates:

Copper-gold:

- 85.3% Cu recovery
- Concentrate: ~28.0% Cu & 3.0 g/t Au
- Low deleterious elements

Zinc:

- 89.5% Zn recovery
- Concentrate: 52-55% Zn
- Low deleterious elements

Lead-silver:

- 53.6% Pb recovery
- Concentrate: ~55% Pb & 1,750 g/t Ag

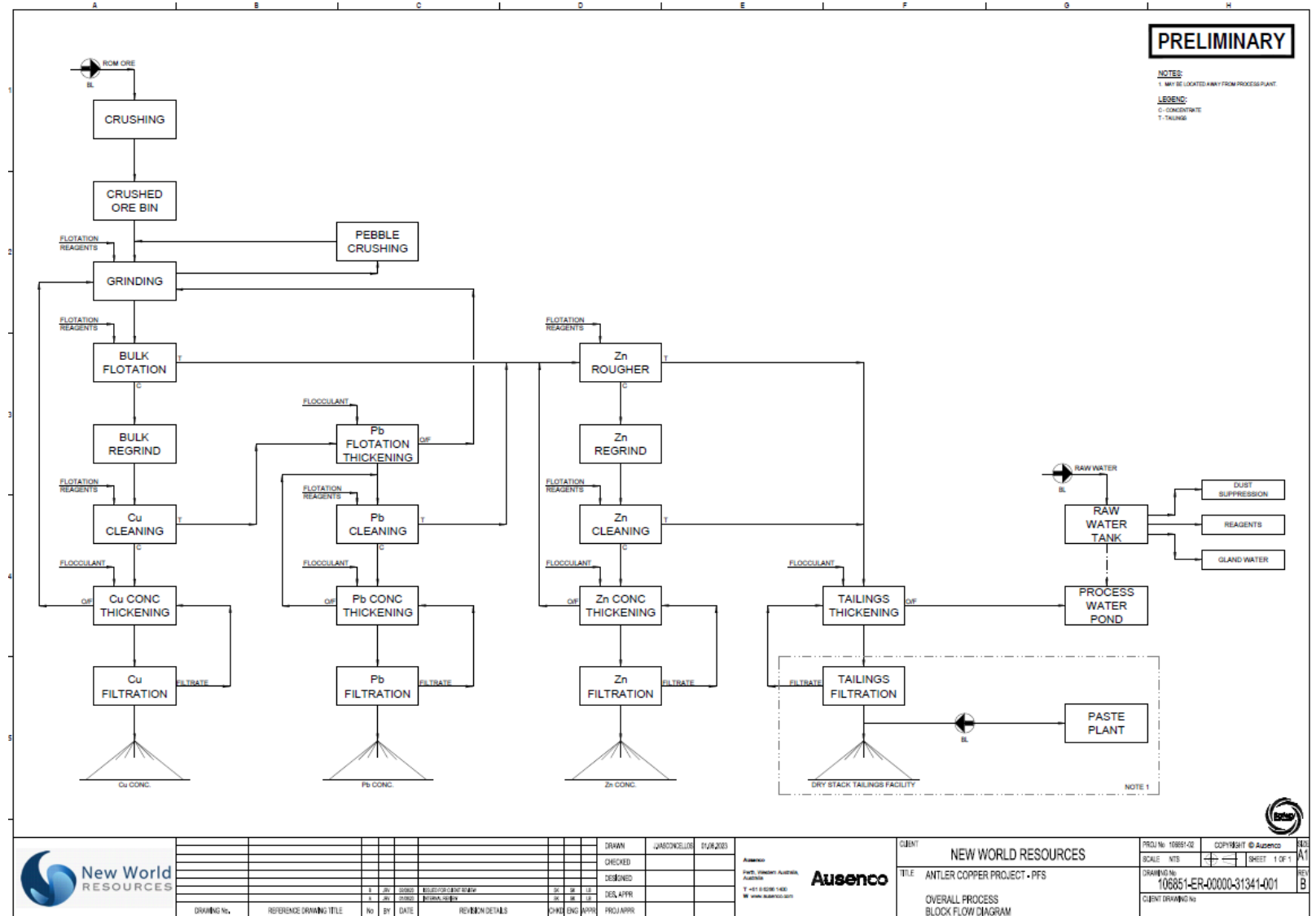

	<table border="1"> <tr> <th>DRAWN</th> <td>JAMONKELON</td> <td>11/1/2023</td> </tr> <tr> <th>CHECKED</th> <td></td> <td></td> </tr> <tr> <th>DESIGNED</th> <td></td> <td></td> </tr> <tr> <th>DES. APPR</th> <td></td> <td></td> </tr> <tr> <th>CHKD ENG APPR</th> <td></td> <td></td> </tr> <tr> <th>PROJ APPR</th> <td></td> <td></td> </tr> </table>	DRAWN	JAMONKELON	11/1/2023	CHECKED			DESIGNED			DES. APPR			CHKD ENG APPR			PROJ APPR				<table border="1"> <tr> <th>CLIENT</th> <td>NEW WORLD RESOURCES</td> </tr> <tr> <th>TITLE</th> <td>ANTLER COPPER PROJECT - PFS</td> </tr> <tr> <th>OVERALL PROCESS</th> <td>BLOCK FLOW DIAGRAM</td> </tr> </table>	CLIENT	NEW WORLD RESOURCES	TITLE	ANTLER COPPER PROJECT - PFS	OVERALL PROCESS	BLOCK FLOW DIAGRAM	<table border="1"> <tr> <td>PROJ. No.</td> <td>10685-02</td> <td>CDP/REGIT © Ausenco</td> </tr> <tr> <td>SCALE</td> <td>N/A</td> <td>SHEET 1 OF 1</td> </tr> <tr> <td>DRAWING No.</td> <td>10685-ER-00000-31341-001</td> <td></td> </tr> <tr> <td>CLIENT DRAWING No.</td> <td></td> <td></td> </tr> </table>	PROJ. No.	10685-02	CDP/REGIT © Ausenco	SCALE	N/A	SHEET 1 OF 1	DRAWING No.	10685-ER-00000-31341-001		CLIENT DRAWING No.		
	DRAWN	JAMONKELON	11/1/2023																																					
CHECKED																																								
DESIGNED																																								
DES. APPR																																								
CHKD ENG APPR																																								
PROJ APPR																																								
CLIENT	NEW WORLD RESOURCES																																							
TITLE	ANTLER COPPER PROJECT - PFS																																							
OVERALL PROCESS	BLOCK FLOW DIAGRAM																																							
PROJ. No.	10685-02	CDP/REGIT © Ausenco																																						
SCALE	N/A	SHEET 1 OF 1																																						
DRAWING No.	10685-ER-00000-31341-001																																							
CLIENT DRAWING No.																																								
<table border="1"> <tr> <th>DRAWING No.</th> <th>REFERENCE DRAWING TITLE</th> <th>No</th> <th>BY</th> <th>DATE</th> <th>REVISION DETAILS</th> <th>CHKD</th> <th>ENG</th> <th>APPR</th> </tr> <tr> <td></td> <td></td> <td></td> <td></td> <td></td> <td></td> <td></td> <td></td> <td></td> </tr> </table>	DRAWING No.	REFERENCE DRAWING TITLE	No	BY	DATE	REVISION DETAILS	CHKD	ENG	APPR																															
DRAWING No.	REFERENCE DRAWING TITLE	No	BY	DATE	REVISION DETAILS	CHKD	ENG	APPR																																



Appendix 7 – 2023 Scoping Study: Metal Production by Year

Average Annual Production (Yrs 2-11)

32,700t Cu-Equiv.

Average Annual Production (Yrs 2-11)

16,400t Copper

Average Annual Production (Yrs 2-11)

37,900t Zinc

Average Annual Production (Yrs 2-11)

5,300t Lead

Average Annual Production (Yrs 2-11)

660,000 oz Silver

Average Annual Production (Yrs 2-11)

5,000 oz Gold

Payable Contained Metal Production by Year (Tonnes)

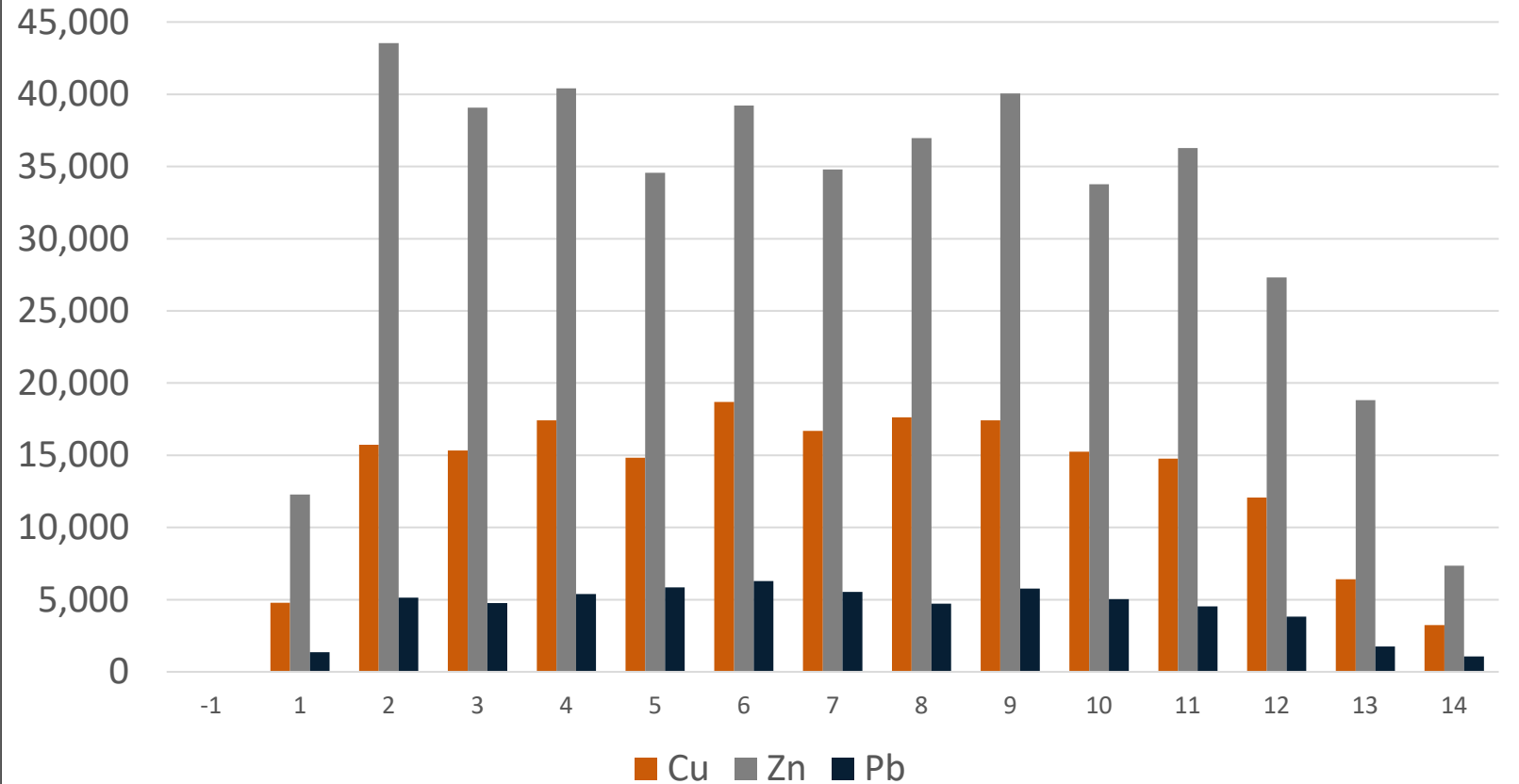

Refer Slide 3 for Cautionary Statement on Inferred Resources



Appendix 8 – Pre-Feasibility Study Progress

- **NWC remains on schedule to complete a PFS by the end of 2023.**
 - Mine design updated;
 - Paste-fill and tailings deposition testwork well advanced;
 - Water drilling completed with pipeline route & pumping system designed;
 - Surface and underground geotechnical site investigations complete; and
 - Surface infrastructure design (facilities, tailings storage and processing infrastructure) almost complete.
- **Multiple industry leading experts working on the PFS, with extensive experience in developing projects in Arizona.**



Geotechnical Logging of Drill Core for Mine Design – Entech



Surface Geotechnical Investigation – Cascade Drilling

<p>Study Author, Process Design and Infrastructure</p>	<p>Mine Design & Scheduling and UG Geotechnical</p>	<p>Metallurgical Testwork</p>	<p>Tailings Management and Backfill</p>	<p>Regulatory & Permitting</p> <p>Passionate About Our Work. Passionate About Our People westlandresources.com</p>
<p>Geochemical Characterization</p>	<p>Hydrogeology</p>	<p>Mineral Resource Estimation</p>	<p>Geotechnical Testing</p>	<p>Environmental Monitoring</p>